

W.C.CURTISS
2016

HF 3

HF 4

HF 5

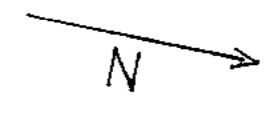

| | | | |
|-----|----|-----------|---------------|
| 90 | 87 | McINTOSH | WEBSTER ABELL |
| 91 | 86 | LUTHER | SEAMAN |
| 92 | 85 | LUTHER | ? |
| 93 | 84 | LEWIS | LANG-WORTHY |
| 94 | 83 | HUBBELL | WEAVER |
| 95 | 82 | NICHOLSON | HOLMES |
| 96 | 81 | BARRETT | NICHOLSON |
| 97 | 80 | ARNOLD | BENNETT |
| 98 | 79 | LUTHER | FULLER |
| 99 | 78 | TAFT | REDMOND |
| 100 | 77 | | HOLMES |
| 101 | 76 | VAULT | McKITT-RICK |

| | | | |
|-----------|-----------------|------------------|---------------------|
| J.M. COOK | SEAMAN | FISHER STOCKWELL | McINTOSH POTTER |
| | PERRY | | |
| STILLWELL | STILLWELL | PERRY | VAUDENBURGH BOSWELL |
| STILLWELL | STILLWELL | CLAPP | ? |
| MARSHALL | MARSHALL PALMER | PALMER | O'DELL ? |
| SMITH | MIDDLEBROOK | CHARLETON | FLINT |
| RAYMOND | RICHE | HUBBELL | HODGES |
| ROBERTSON | WAKEMAN | WAKEMAN | FINCH |
| McINTOSH | WAKEMAN | WAKEMAN | EVERETT |
| RAYMOND | RAYMOND WAKEMAN | DAVIE | CLARK FORD |
| SMITH | SMITH | BURLES | BARTON |
| SMITH | A.W. SMITH | BURTIS | SHEPARD |

| | |
|-----|-----|
| 146 | 146 |
| 145 | 147 |
| 144 | 148 |
| 143 | 149 |
| 142 | 150 |
| 141 | 152 |
| 140 | 153 |
| 139 | 154 |
| 138 | 155 |
| 137 | 156 |
| 136 | 157 |
| 135 | 158 |
| 134 | 159 |
| 133 | 160 |
| 132 | 161 |
| 131 | 162 |
| 130 | 163 |
| 129 | 164 |
| 128 | 165 |
| 127 | 166 |
| 126 | 167 |
| 125 | 168 |
| 124 | 169 |
| 123 | 170 |
| 122 | 171 |
| 121 | 172 |
| 120 | 173 |
| 119 | 174 |
| 118 | 175 |
| 117 | 176 |

| | |
|-----|-----|
| 177 | 207 |
| 178 | 208 |
| 179 | 209 |
| 180 | 210 |
| 181 | 211 |
| 182 | 212 |
| 183 | 213 |
| 184 | 214 |
| 185 | 215 |
| 186 | 216 |
| 187 | 217 |
| 188 | 218 |
| 189 | 219 |
| 190 | 220 |
| 191 | 221 |
| 192 | 222 |
| 193 | 223 |
| 194 | 224 |
| 195 | 225 |
| 196 | 226 |
| 197 | 227 |
| 198 | 228 |
| 199 | 229 |
| 200 | 230 |
| 201 | 231 |
| 202 | 232 |
| 203 | 233 |
| 204 | 234 |
| 205 | 235 |
| 206 | 236 |

| | | |
|-----|----|----|
| 102 | 75 | 46 |
| 103 | 74 | 47 |
| 104 | 73 | 48 |
| 105 | 72 | 49 |
| 106 | 71 | 50 |
| 107 | 70 | 51 |
| 108 | 69 | 52 |
| 109 | 68 | 53 |
| 110 | 67 | 54 |
| 111 | 66 | 55 |
| 112 | 65 | 56 |
| 113 | 64 | 57 |
| 114 | 63 | 58 |
| 115 | 62 | 59 |
| 116 | 61 | 60 |

| | | | |
|--|----|--|--|
| | 45 | | |
| | 44 | | |
| | 43 | | |
| | 42 | | |
| | 41 | | |
| | 40 | | |
| | 39 | | |
| | 38 | | |
| | 37 | | |
| | 36 | | |
| | 35 | | |
| | 34 | | |
| | 33 | | |
| | 32 | | |
| | 31 | | |

| | | | |
|-------------|----|-----------|--|
| | | FORRESTER | |
| | | THAYER | |
| THOMPSON | | DAVIE | |
| | 16 | 15 | |
| | 17 | 14 | |
| | 18 | 13 | |
| | 19 | 12 | |
| | 20 | 11 | |
| | 21 | 10 | |
| | 22 | 9 | |
| | 23 | 8 | |
| | 24 | 7 | |
| | 25 | 6 | |
| | 26 | 5 | |
| | 27 | 4 | |
| | 28 | 3 | |
| | 29 | 2 | |
| | 30 | | |
| J.W. HORTON | | | |

| | |
|-----|-----|
| 161 | 221 |
| 162 | 222 |
| 163 | 223 |
| 164 | 224 |
| 165 | 225 |
| 166 | 226 |
| 167 | 227 |
| 168 | 228 |
| 169 | 229 |
| 170 | 230 |
| 171 | 231 |
| 172 | 232 |
| 173 | 233 |
| 174 | 234 |
| 175 | 235 |
| 176 | 236 |

HF 3

HF 4

HF 5

| | | | |
|----|----|----|----|
| 99 | 78 | 77 | 56 |
| 98 | 79 | 76 | 57 |
| 97 | 80 | 75 | 58 |
| 96 | 81 | 74 | 59 |
| 95 | 82 | 73 | 60 |
| 94 | 83 | 72 | 61 |
| 93 | 84 | 71 | 62 |
| 92 | 85 | 70 | 63 |
| 91 | 86 | 69 | 64 |
| 90 | 87 | 68 | 65 |
| 89 | 88 | 67 | 66 |

SEC
D

| | | | |
|----|----|----|----|
| 34 | 33 | 12 | 11 |
| 35 | 32 | 13 | 10 |
| 36 | 31 | 14 | 9 |
| 37 | 30 | 15 | 8 |
| 38 | 29 | 16 | 7 |
| 39 | 28 | 17 | 6 |
| 40 | 27 | 18 | 5 |
| 41 | 26 | 19 | 4 |
| 42 | 25 | 20 | 3 |
| 43 | 24 | 21 | 2 |
| 44 | 23 | 22 | 1 |

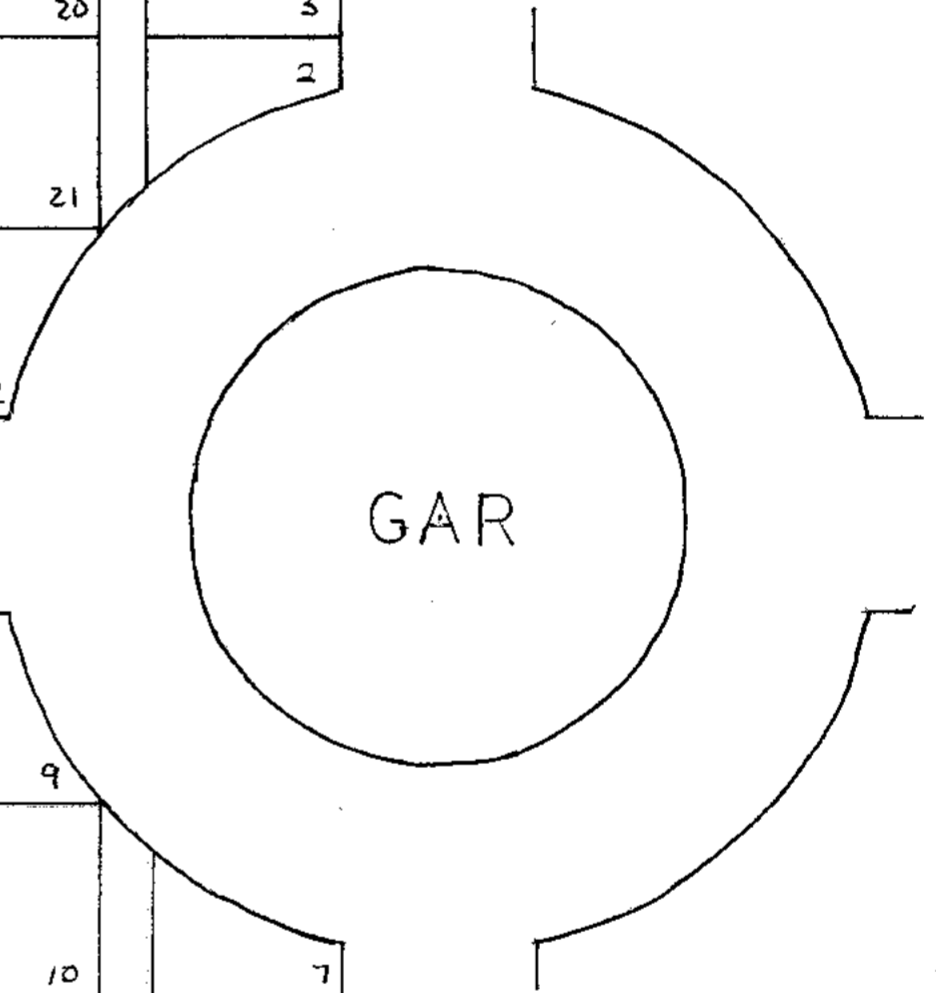
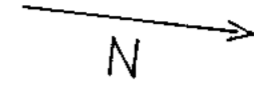

| | | | |
|----|----|----|----|
| 72 | 57 | 56 | 41 |
| 71 | 58 | 55 | 42 |
| 70 | 59 | 54 | 43 |
| 69 | 60 | 53 | 44 |
| 68 | 61 | 52 | 45 |
| 67 | 62 | 51 | 46 |
| 66 | 63 | 50 | 47 |
| 65 | 64 | 49 | 48 |

SEC
C

| | | | |
|----|----|----|---|
| 25 | 24 | 9 | 7 |
| 26 | 23 | 10 | 6 |
| 27 | 22 | 11 | 5 |
| 28 | 21 | 12 | 4 |
| 29 | 20 | 13 | 3 |
| 30 | 19 | 14 | 2 |
| 31 | 18 | 15 | 1 |
| 32 | 17 | 16 | 1 |

| | | | | | | | |
|----|----|----|----|----|----|----|----|
| 98 | 77 | 76 | 55 | 33 | 32 | 11 | 10 |
| 97 | 78 | 75 | 56 | 34 | 31 | 12 | 9 |
| 96 | 79 | 74 | 57 | 35 | 30 | 13 | 8 |
| 95 | 80 | 73 | 58 | 36 | 29 | 14 | 7 |
| 94 | 81 | 72 | 59 | 37 | 28 | 15 | 6 |
| 93 | 82 | 71 | 60 | 38 | 27 | 16 | 5 |
| 92 | 83 | 70 | 61 | 39 | 26 | 17 | 4 |
| 91 | 84 | 69 | 62 | 40 | 25 | 18 | 3 |
| 90 | 85 | 68 | 63 | 41 | 24 | 19 | 2 |
| 89 | 86 | 67 | 64 | 42 | 23 | 20 | 1 |
| | 87 | 66 | 65 | 43 | 22 | 21 | |

SEC
E

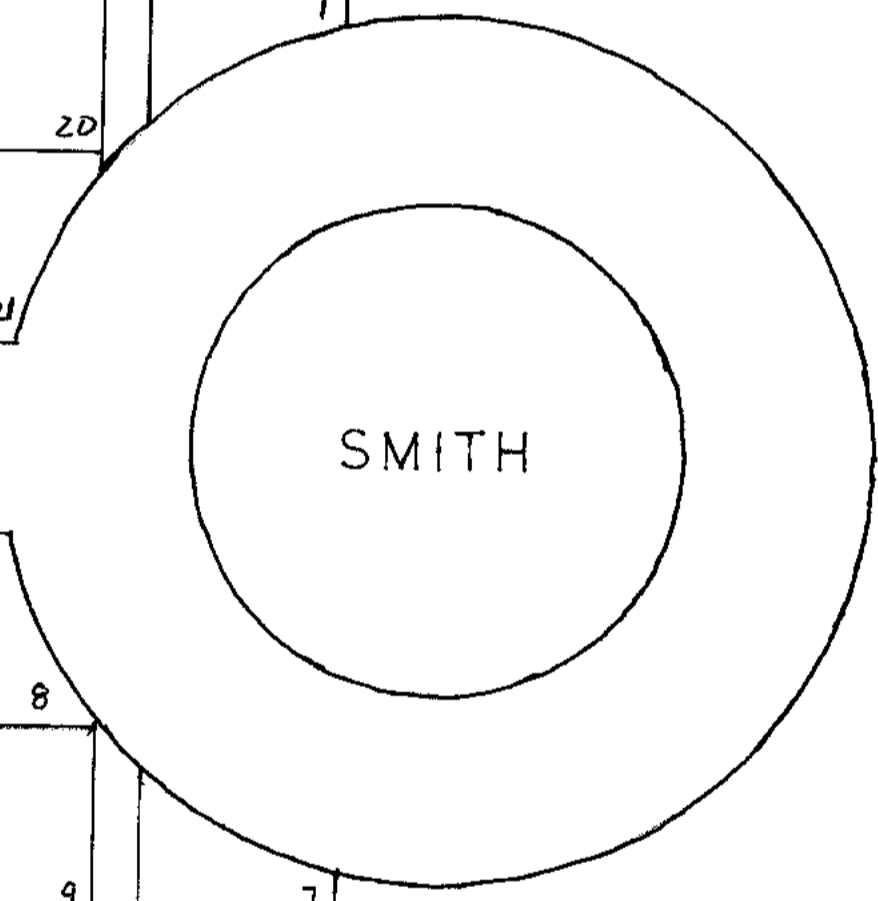
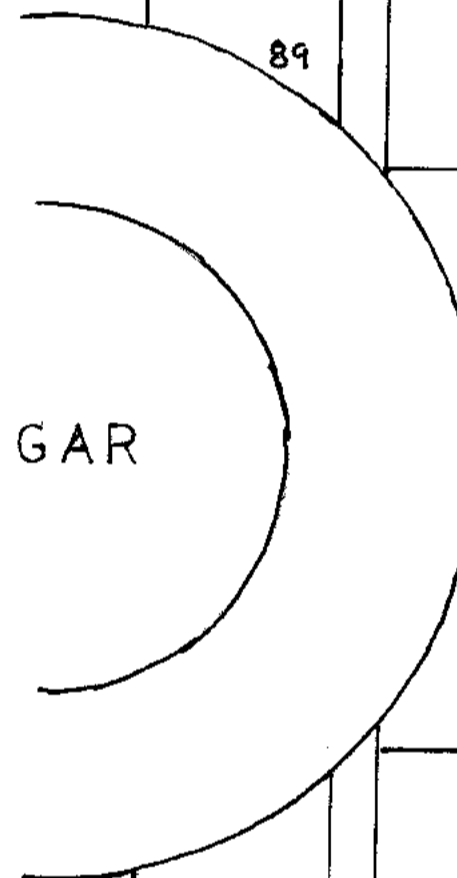
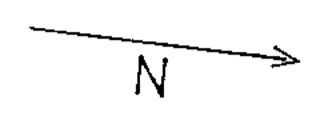

| | | | | | | | |
|----|----|----|----|----|----|----|---|
| | 56 | 55 | 40 | 24 | 23 | 8 | |
| 70 | 57 | 54 | 41 | 25 | 22 | 9 | 7 |
| 69 | 58 | 53 | 42 | 26 | 21 | 10 | 6 |
| 68 | 59 | 52 | 43 | 27 | 20 | 11 | 5 |
| 67 | 60 | 51 | 44 | 28 | 19 | 12 | 4 |
| 66 | 61 | 50 | 45 | 29 | 18 | 13 | 3 |
| 65 | 62 | 49 | 46 | 30 | 17 | 14 | 2 |
| 64 | 63 | 48 | 47 | 31 | 16 | 15 | 1 |

SEC
B

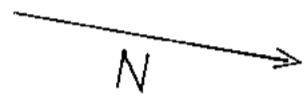

| | | | | | | | | | | |
|----|----|----|----|----|--------|----|----|----|-----|-----|
| 10 | 11 | 32 | 33 | 54 | | 76 | 77 | 98 | 99 | 120 |
| 9 | 12 | 31 | 34 | 53 | | 75 | 78 | 97 | 100 | 119 |
| 8 | 13 | 30 | 35 | 52 | | 74 | 79 | 96 | 101 | 118 |
| 7 | 14 | 29 | 36 | 51 | | 73 | 80 | 95 | 102 | 117 |
| 6 | 15 | 28 | 37 | 50 | | 72 | 81 | 94 | 103 | 116 |
| 5 | 16 | 27 | 38 | 49 | SEC. F | 71 | 82 | 93 | 104 | 115 |
| 4 | 17 | 26 | 39 | 48 | ↔ | 70 | 83 | 92 | 105 | 114 |
| 3 | 18 | 25 | 40 | 47 | | 69 | 84 | 91 | 106 | 113 |
| 2 | 19 | 24 | 41 | 46 | | 68 | 85 | 90 | 107 | 112 |
| 1 | 20 | 23 | 42 | 45 | | 67 | 86 | 89 | 108 | 111 |
| | 21 | 22 | 43 | 44 | | 66 | 87 | 88 | 109 | 110 |

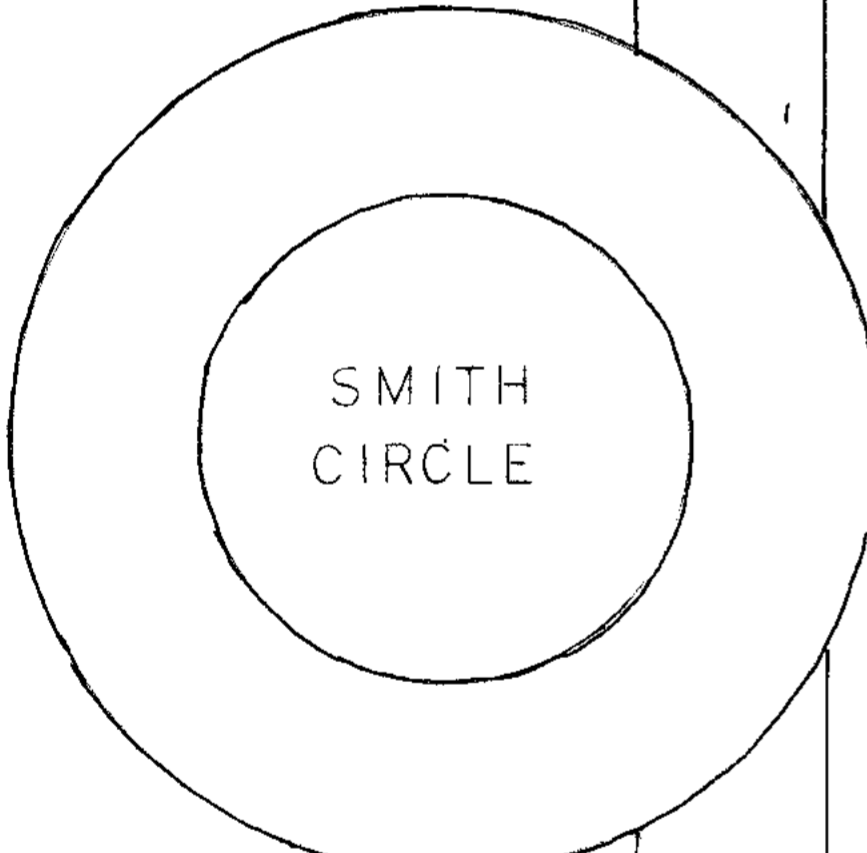

| | | | | | | | | | | |
|---|----|----|----|----|--------|-----------|-------|----|-----------|----|
| | 8 | 19 | 20 | 27 | | 35 | 39 | 40 | 47 | 48 |
| 7 | 9 | 18 | 21 | 26 | | 34 | 38 | 41 | 46 | 49 |
| 6 | 10 | 17 | 22 | 25 | | 33 | 37 | 42 | 45 | 50 |
| 5 | 11 | 16 | 23 | 24 | | 32 | 36 | 43 | 44 | 51 |
| 4 | 12 | | | | SEC. A | | | | | |
| 3 | 13 | | | | | BURKE | COONS | | | |
| 2 | 14 | | | | HAIGHT | | | | | |
| 1 | 15 | | | | | DONALDSON | | | GILLESPIE | |

BSA

| | | | | | | | | |
|----|----|----|----|----|----|----|----|---|
| 72 | 57 | 56 | 41 | 40 | 25 | 24 | 9 | 8 |
| 71 | 58 | 55 | 42 | 39 | 26 | 23 | 10 | 7 |
| 70 | 59 | 54 | 43 | 38 | 27 | 22 | 11 | 6 |
| 69 | 60 | 53 | 44 | 37 | 28 | 21 | 12 | 5 |
| 68 | 61 | 52 | 45 | 36 | 29 | 20 | 13 | 4 |
| 67 | 62 | 51 | 46 | 35 | 30 | 19 | 14 | 3 |
| 66 | 63 | 50 | 47 | 34 | 31 | 18 | 15 | 2 |
| 65 | 64 | 49 | 48 | 33 | 32 | 17 | 16 | 1 |

ASA

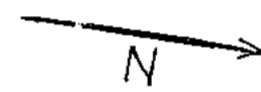

| | | | | | | | | |
|-----|-----|-----|-----|-----|-----|-----|-----|----|
| 72 | 57 | 56 | 41 | 40 | 25 | 24 | 9 | 8 |
| 71 | 58 | 55 | 42 | 39 | 26 | 23 | 10 | 7 |
| 70 | 59 | 54 | 43 | | | 22 | 11 | 6 |
| 69 | 60 | 53 | 44 | | | 21 | 12 | 5 |
| 68 | 61 | 52 | 45 | | | 20 | 13 | 4 |
| 67 | 62 | 51 | 46 | 35 | 30 | 19 | 14 | 3 |
| 66 | 63 | 50 | 47 | 34 | 31 | 18 | 15 | 2 |
| 65 | 64 | 49 | 48 | 33 | 32 | 17 | 16 | 1 |
| 65A | 64A | 49A | 48A | 33A | 32A | 17A | 16A | 1A |
| 65B | 64B | 49B | 48B | 33B | 32B | 17B | 16B | 1B |
| 65C | 64C | 49C | 48C | 33C | 32B | 17C | 16C | 1C |

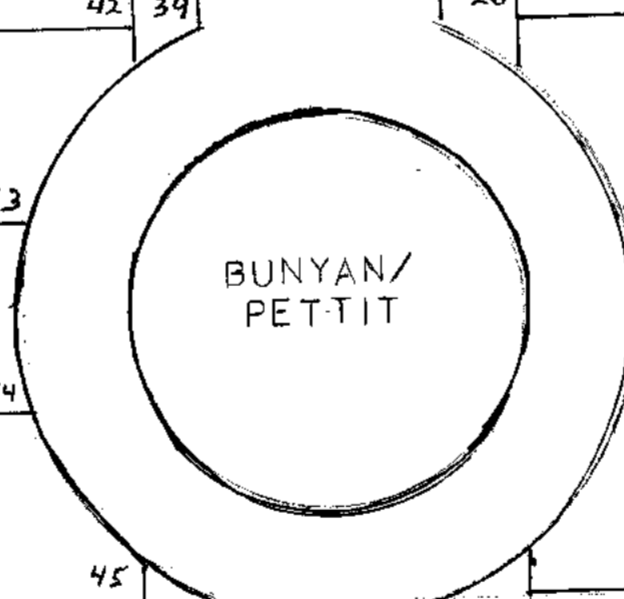

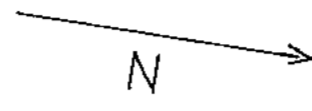

CSA

| | | | | | | | | | |
|----|----|----|----|----|----|----|----|----|----|
| | | | | | | | | 00 | 00 |
| | | | | | | | | | |
| 99 | 78 | 77 | 56 | 55 | 34 | 33 | 12 | 11 | |
| 98 | 79 | 76 | 57 | 54 | 35 | 32 | 13 | 10 | |
| 97 | 80 | 75 | 58 | 53 | 36 | 31 | 14 | 9 | |
| 96 | 81 | 74 | 59 | 52 | 37 | 30 | 15 | 8 | |
| 95 | 82 | 73 | 60 | 51 | 38 | 29 | 16 | 7 | |
| 94 | 83 | 72 | 61 | 50 | 39 | 28 | 17 | 6 | |
| 93 | 84 | 71 | 62 | 49 | 40 | 27 | 18 | 5 | |
| 92 | 85 | 70 | 63 | 48 | 41 | 26 | 19 | 4 | |
| 91 | 86 | 69 | 64 | 47 | 42 | 25 | 20 | 3 | |
| 90 | 87 | 68 | 65 | 46 | 43 | 24 | 21 | 2 | |
| 89 | 88 | 67 | 66 | 45 | 44 | 23 | 22 | 1 | |

EWA

| | | |
|----|----|----|
| | | |
| | 17 | 16 |
| | | |
| | 18 | 15 |
| | | |
| | 19 | 14 |
| | | |
| | 20 | 13 |
| | | |
| | 21 | 12 |
| | | |
| | 22 | 11 |
| | | |
| | 23 | 10 |
| | | |
| | 24 | 9 |
| | | |
| | 25 | 8 |
| | | |
| 39 | 26 | 7 |
| | | |
| 38 | 27 | 6 |
| | | |
| 37 | 28 | 5 |
| | | |
| 36 | 29 | 4 |
| | | |
| 35 | 30 | 3 |
| | | |
| 34 | 31 | 2 |
| | | |
| 33 | 32 | 1 |

PLOT LAYOUT

| | | | | | |
|---|---|---|---|---|---|
| A | B | C | D | E | F |
| G | H | I | J | K | L |

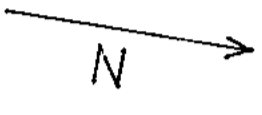
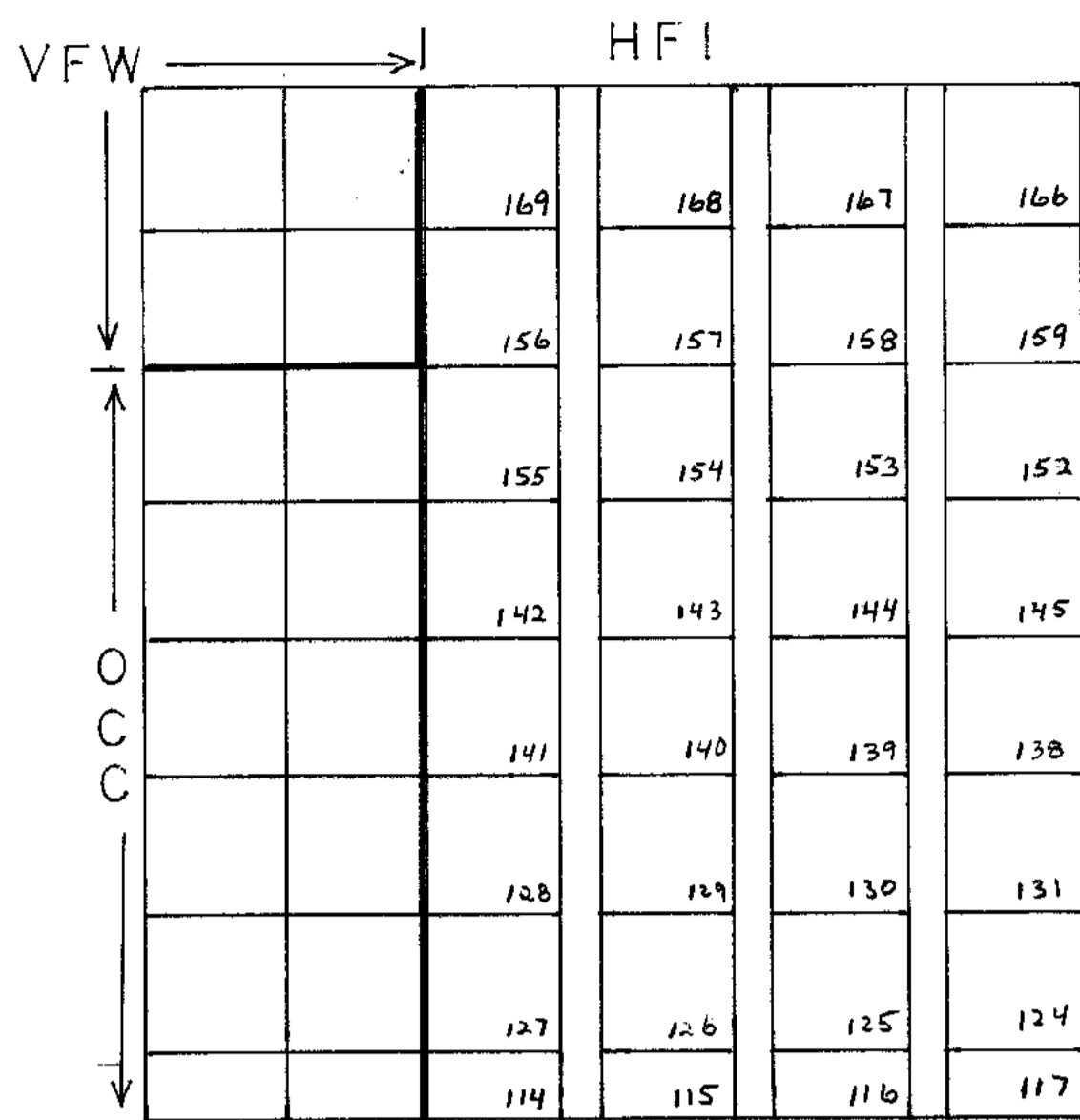

)))))) CREEK))))

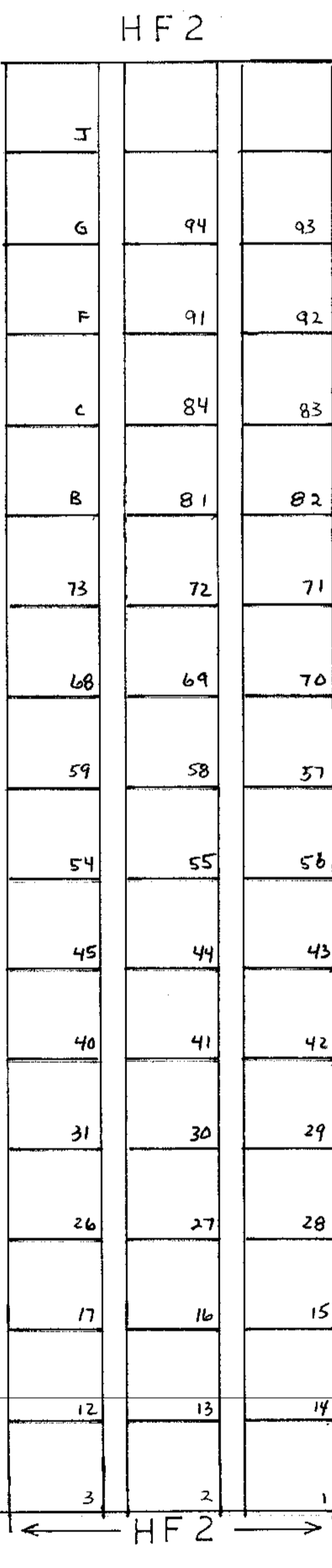
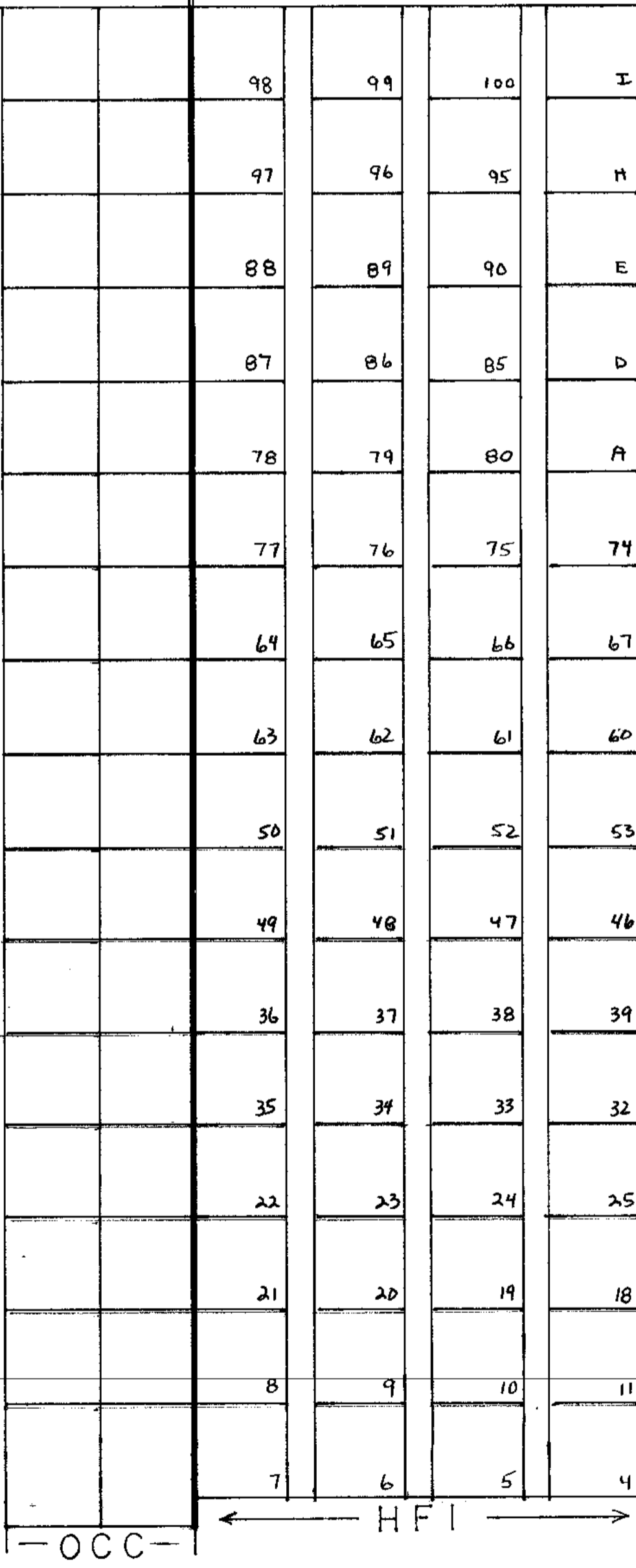

C W A

| | | | | | | | | | | | | | | |
|---|----|----|----|----|----|----|----|----|----|----|----|----|----|----|
| | | | | | | | | | | | | | | |
| | | | | | | | | | | | | | | |
| | | | | | | | | | | | | | | |
| | | 6 | 17 | 20 | 31 | 34 | 45 | 48 | 59 | 62 | 73 | 76 | 87 | 90 |
| 5 | 7 | 16 | 21 | 30 | 35 | 44 | 49 | 58 | 63 | 72 | 77 | 86 | 91 | |
| 4 | 8 | 15 | 22 | 29 | 36 | 43 | 50 | 57 | 64 | 71 | 78 | 85 | 92 | |
| 3 | 9 | 14 | 23 | 28 | 37 | 42 | 51 | 56 | 65 | 70 | 79 | 84 | 93 | |
| 2 | 10 | 13 | 24 | 27 | 38 | 41 | 52 | 55 | 66 | 69 | 80 | 83 | 94 | |
| 1 | 11 | 12 | 25 | 26 | 39 | 40 | 53 | 54 | 67 | 68 | 81 | 82 | 95 | |

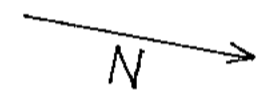

WEST - FLINT ANNEX

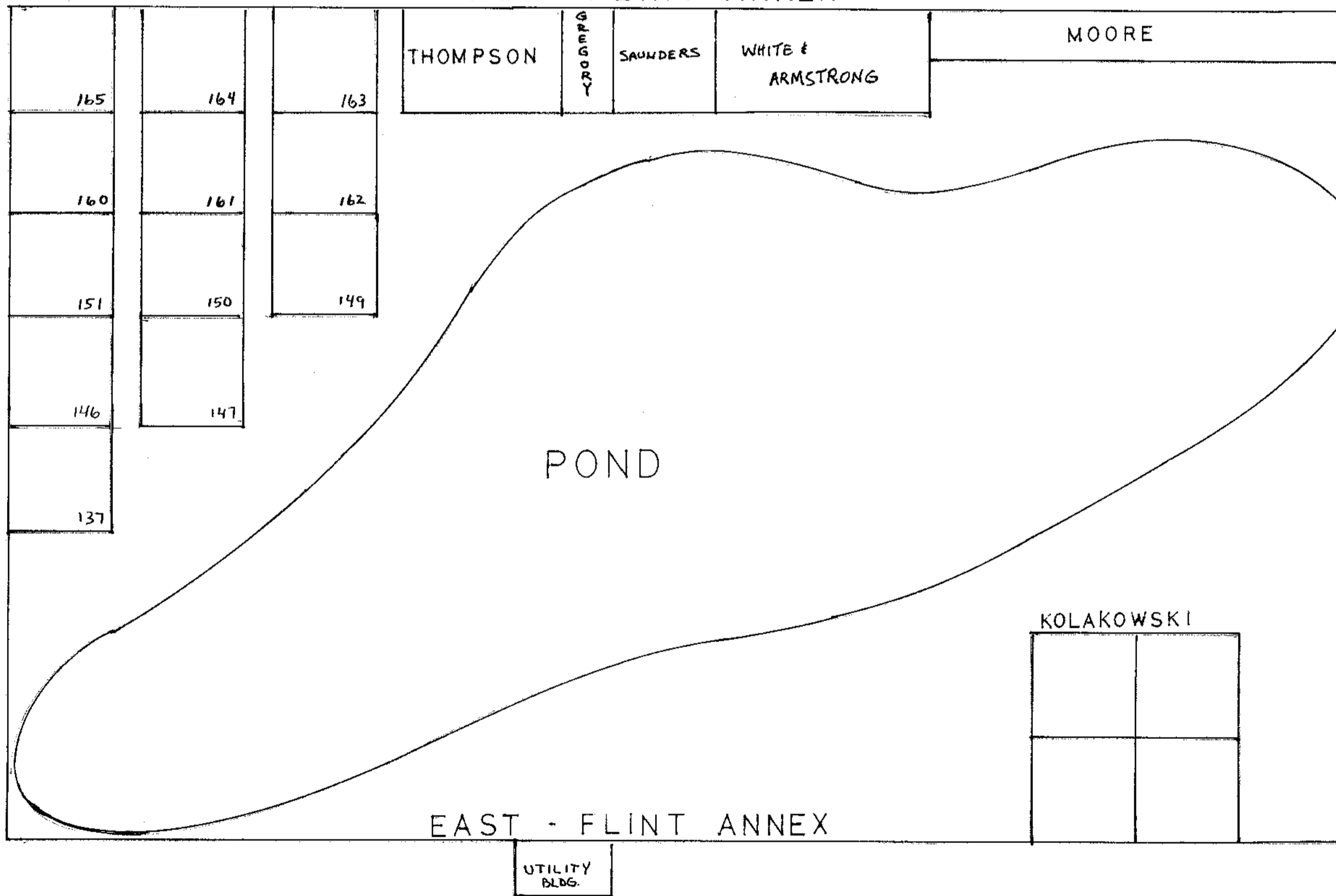

| | | | | | | | | | | | | | | |
|----|-----|-----|-----|-----|-----|-----|-----|-----|-----|-----|-----|-----|-----|------|
| 6B | 11B | 22B | 23B | 38B | 43B | 54B | 59B | 70B | 75B | 86B | 87B | 98B | 99B | 110B |
| 6A | 11A | 22A | 23A | 38A | 43A | 54A | 59A | 70A | 75A | 86A | 87A | 98A | 99A | 110A |
| 6 | 11 | 22 | 23 | 38 | 43 | 54 | 59 | 70 | 75 | 86 | 87 | 98 | 99 | 110 |
| 5 | 12 | 21 | 24 | 37 | 44 | 53 | 60 | 69 | 76 | 85 | 88 | 97 | 100 | 109 |
| 4 | 13 | 20 | 25 | 36 | 45 | 52 | 61 | 68 | 77 | 84 | 89 | 96 | 101 | 108 |
| 3 | 14 | 19 | 26 | 35 | 46 | 51 | 62 | 67 | 78 | 83 | 90 | 95 | 102 | 107 |
| 2 | 15 | 18 | 27 | 34 | 47 | 50 | 63 | 66 | 79 | 82 | 91 | 94 | 103 | 106 |
| 1 | 16 | 17 | 28 | 33 | 48 | 49 | 64 | 65 | 80 | 81 | 92 | 93 | 104 | 105 |

BWA



| | | | | | | | | | | | | | | | | |
|-----|-----|-----|----|----|----|----|----|----|----|----|----|----|----|----|----|---|
| 116 | 103 | 102 | 89 | 88 | 75 | 74 | 61 | 60 | 47 | 46 | 33 | 32 | 19 | 18 | | |
| 115 | 104 | 101 | 90 | 87 | 76 | 73 | 62 | 59 | 48 | 45 | 34 | 31 | 20 | 17 | 6 | |
| 114 | 105 | 100 | 91 | 86 | 77 | 72 | 63 | 58 | 49 | 44 | 35 | 30 | 21 | 16 | 7 | 5 |
| 113 | 106 | 99 | 92 | 85 | 78 | 71 | 64 | 57 | 50 | 43 | 36 | 29 | 22 | 15 | 8 | 4 |
| 112 | 107 | 98 | 93 | 84 | 79 | 70 | 65 | 56 | 51 | 42 | 37 | 28 | 23 | 14 | 9 | 3 |
| 111 | 108 | 97 | 94 | 83 | 80 | 69 | 66 | 55 | 52 | 41 | 38 | 27 | 24 | 13 | 10 | 2 |
| 110 | 109 | 96 | 95 | 82 | 81 | 68 | 67 | 54 | 53 | 40 | 39 | 26 | 25 | 12 | 11 | 1 |

AWA

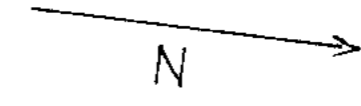

| | | | | | | | | | | |
|----|----|----|----|----|----|----|----|----|----|----|
| | | | | | | | | | | |
| 91 | 90 | 79 | 78 | 67 | 66 | 55 | 54 | 43 | 42 | 31 |
| 92 | 89 | 80 | 77 | 68 | 65 | 56 | 53 | 44 | 41 | 32 |
| 93 | 88 | 81 | 76 | 69 | 64 | 57 | 52 | 45 | 40 | 33 |

| | | | |
|----|----|----|---|
| | | | |
| 19 | 18 | 7 | 6 |
| 20 | 17 | 8 | 5 |
| 21 | 16 | 9 | 4 |
| 22 | 15 | 10 | 3 |

| | | | | | | | | | | | | | | | | |
|----|----|----|----|----|----|----|----|----|----|----|----|----|----|----|----|---|
| | | | | | | | | | | | | | | | | |
| 98 | 95 | 86 | 83 | 74 | 71 | 62 | 59 | 50 | 47 | 38 | 35 | 26 | 23 | 14 | 11 | 2 |
| 97 | 96 | 85 | 84 | 73 | 72 | 61 | 60 | 49 | 48 | 37 | 36 | 25 | 24 | 13 | 12 | 1 |

Section G